

# DOT-TO-DOT VEHICLE

# DRAWING BOOK

24

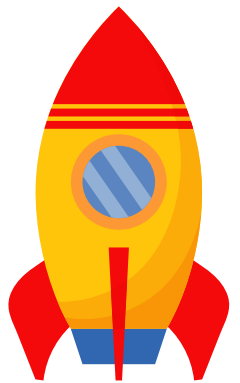

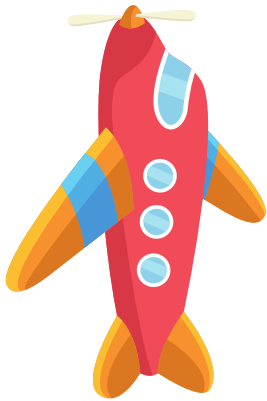
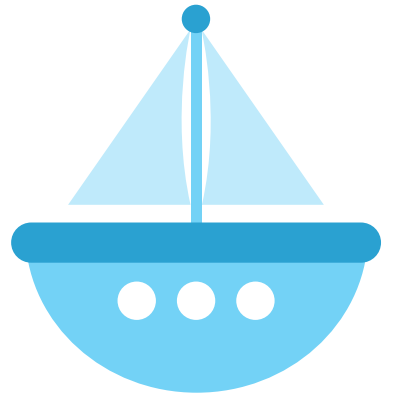
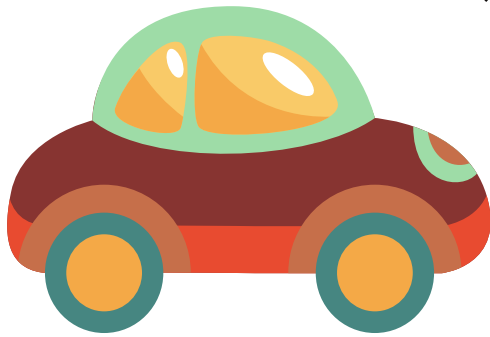

24

# BRAINIAC WORKSHEETS

**Inspire, Engage, &  
Educate Young Minds**

**Written by**

*Snehasish Mondal*

&

*Simran Mondal*



# SAILBOAT

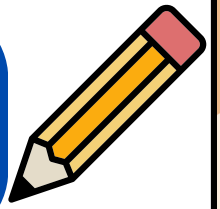

Complete the dot-to-dot and color the vehicle:

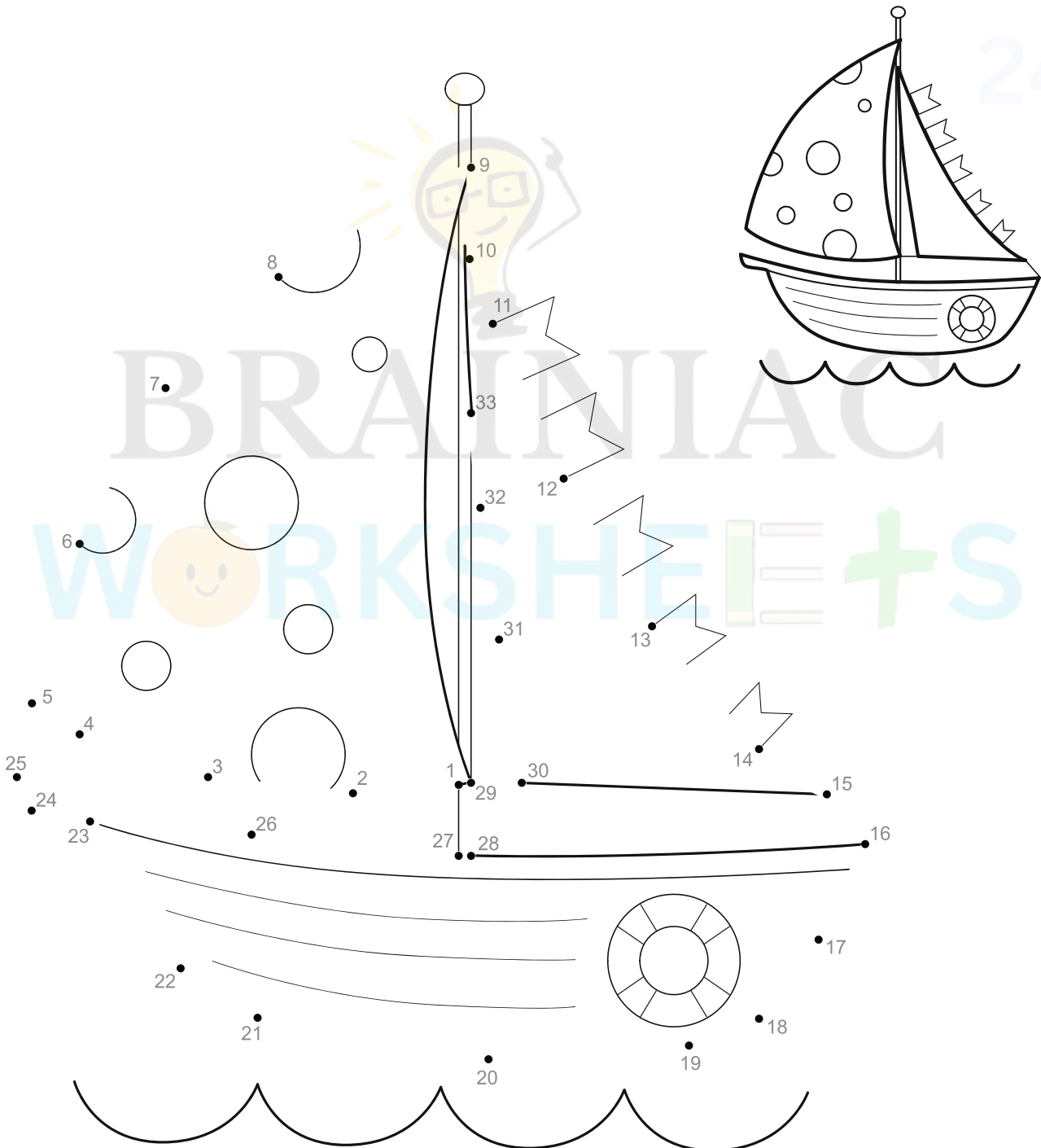

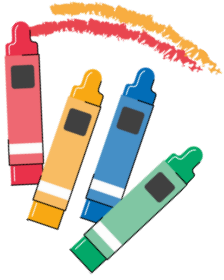

# ROCKET

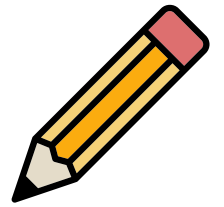

Complete the dot-to-dot and color the vehicle:

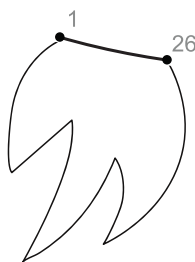
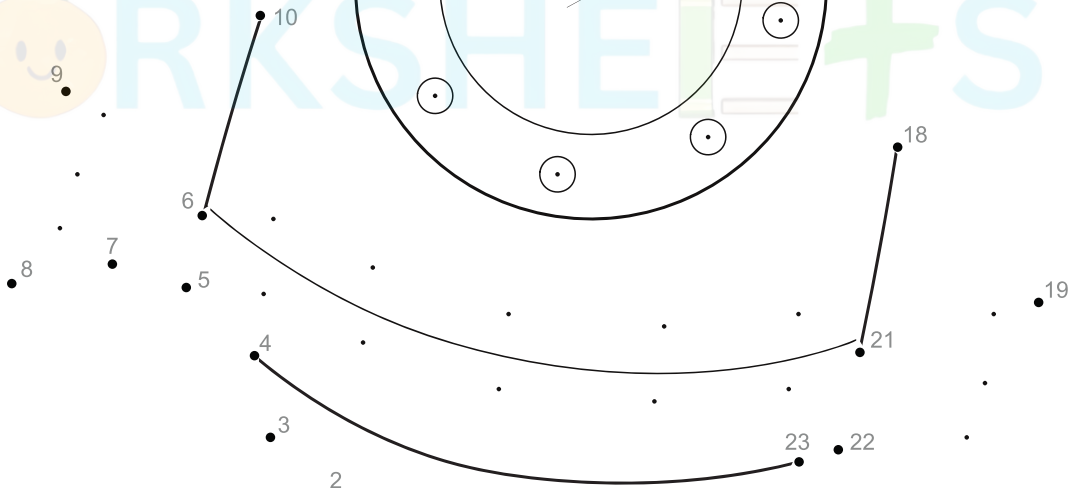
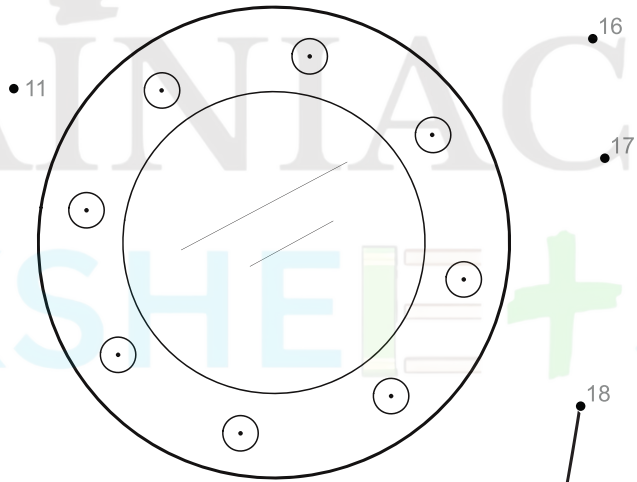
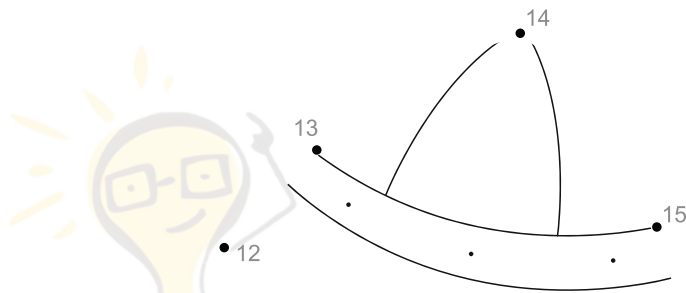
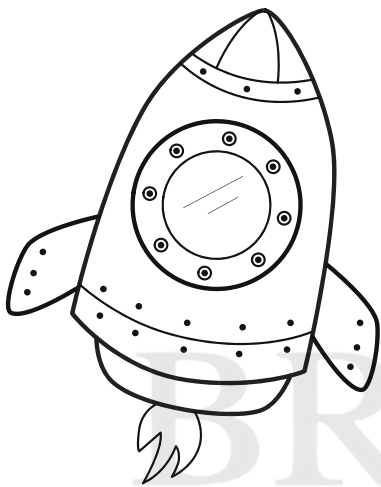



# TRACTOR

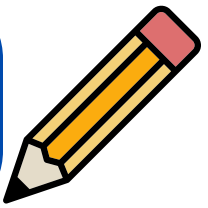

Complete the dot-to-dot and color the vehicle:

24

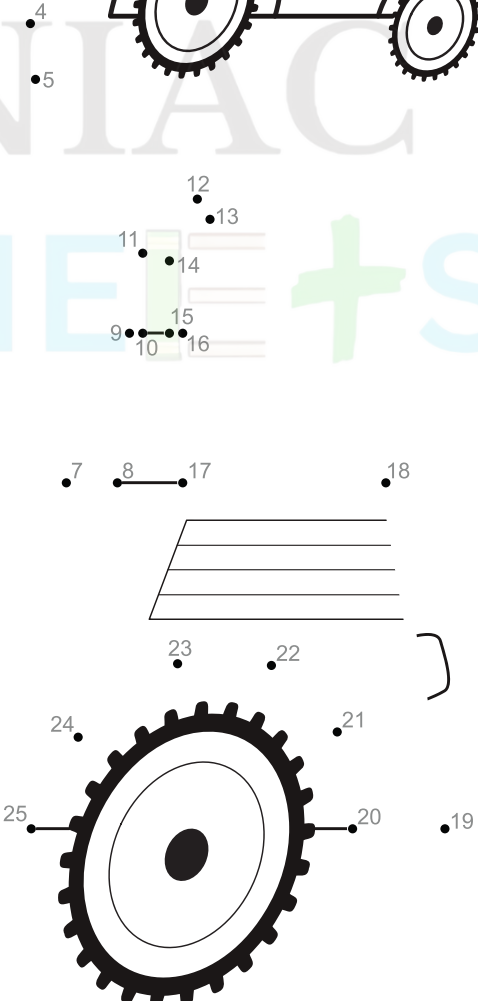
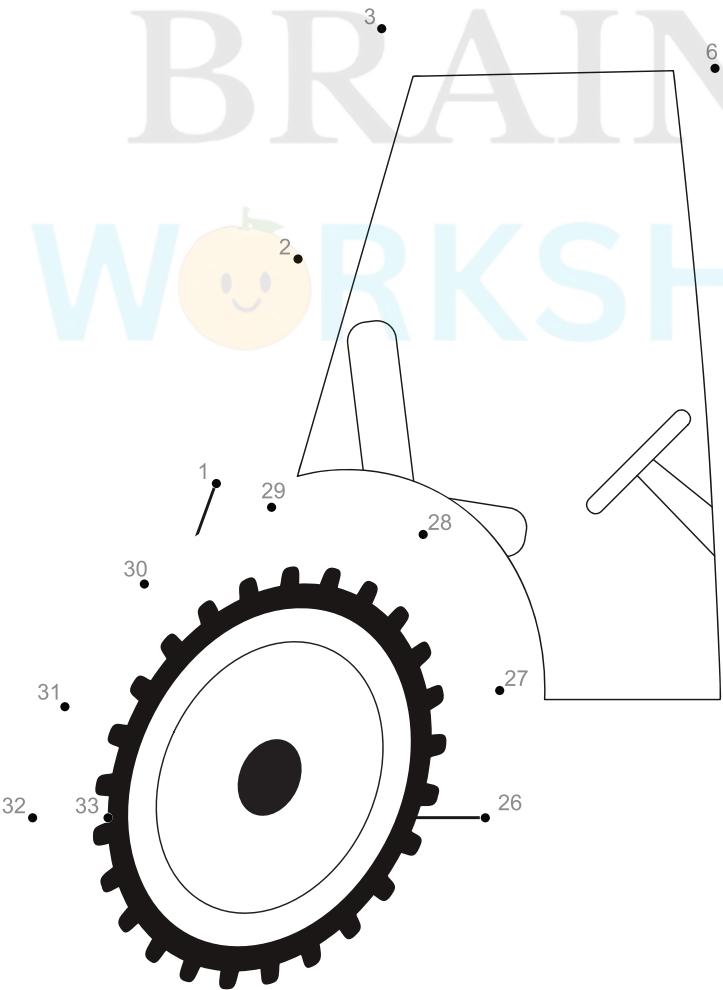



# TRUCK

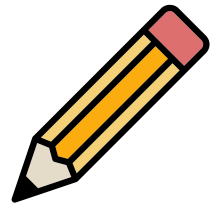

Complete the dot-to-dot and color the vehicle:

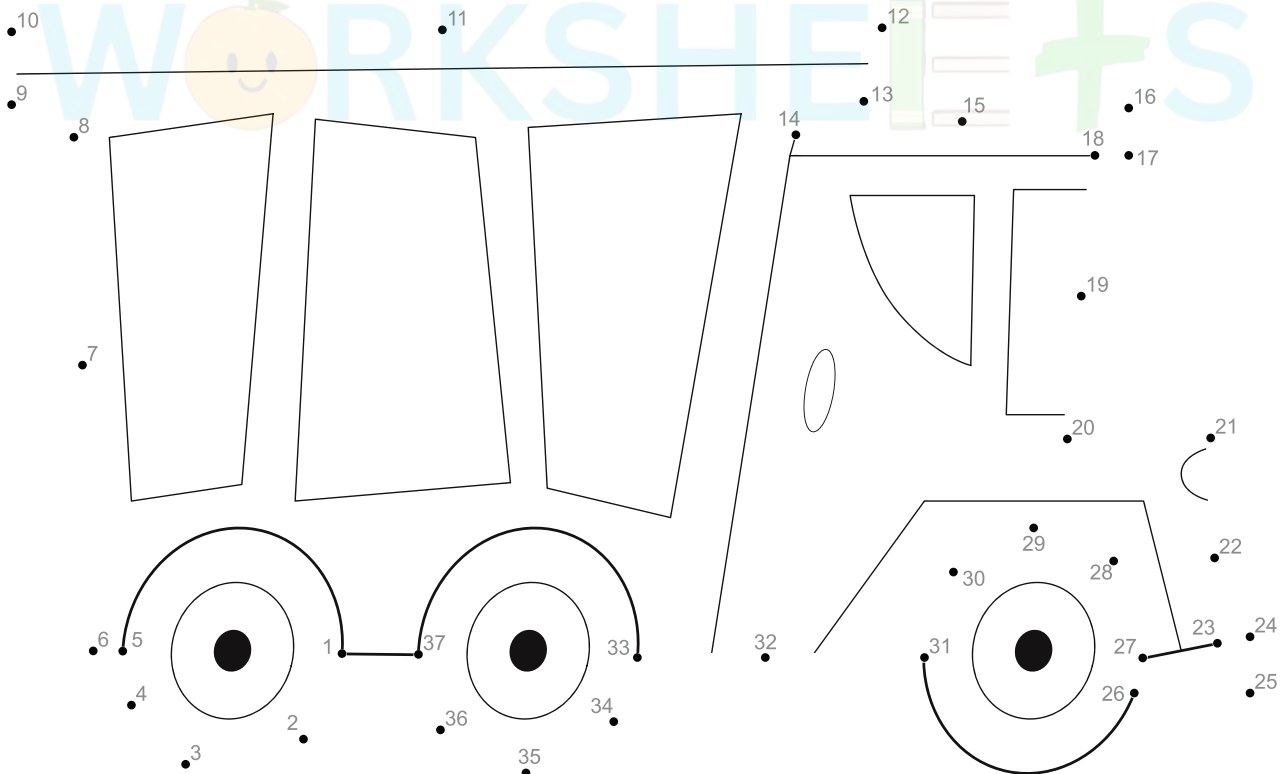
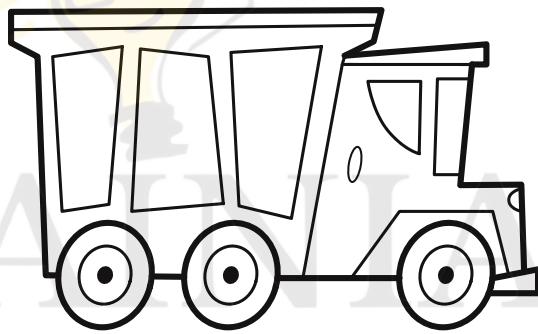

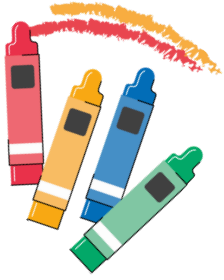

# BUS

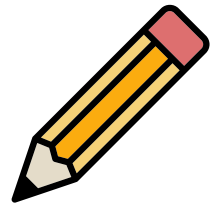

Complete the dot-to-dot and color the vehicle:

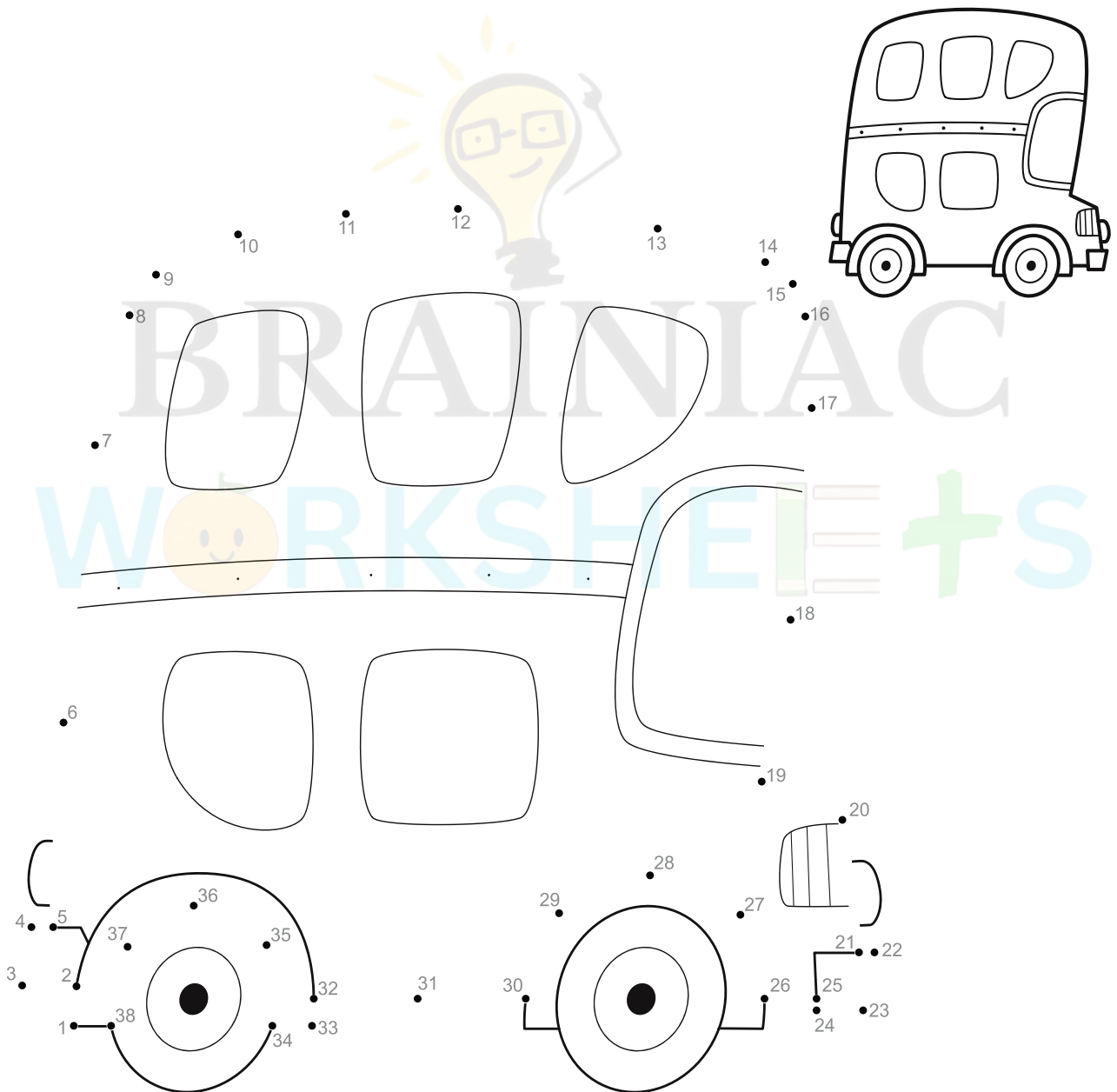

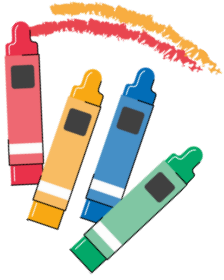

# MOPED

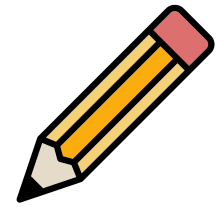

Complete the dot-to-dot and color the vehicle:

24

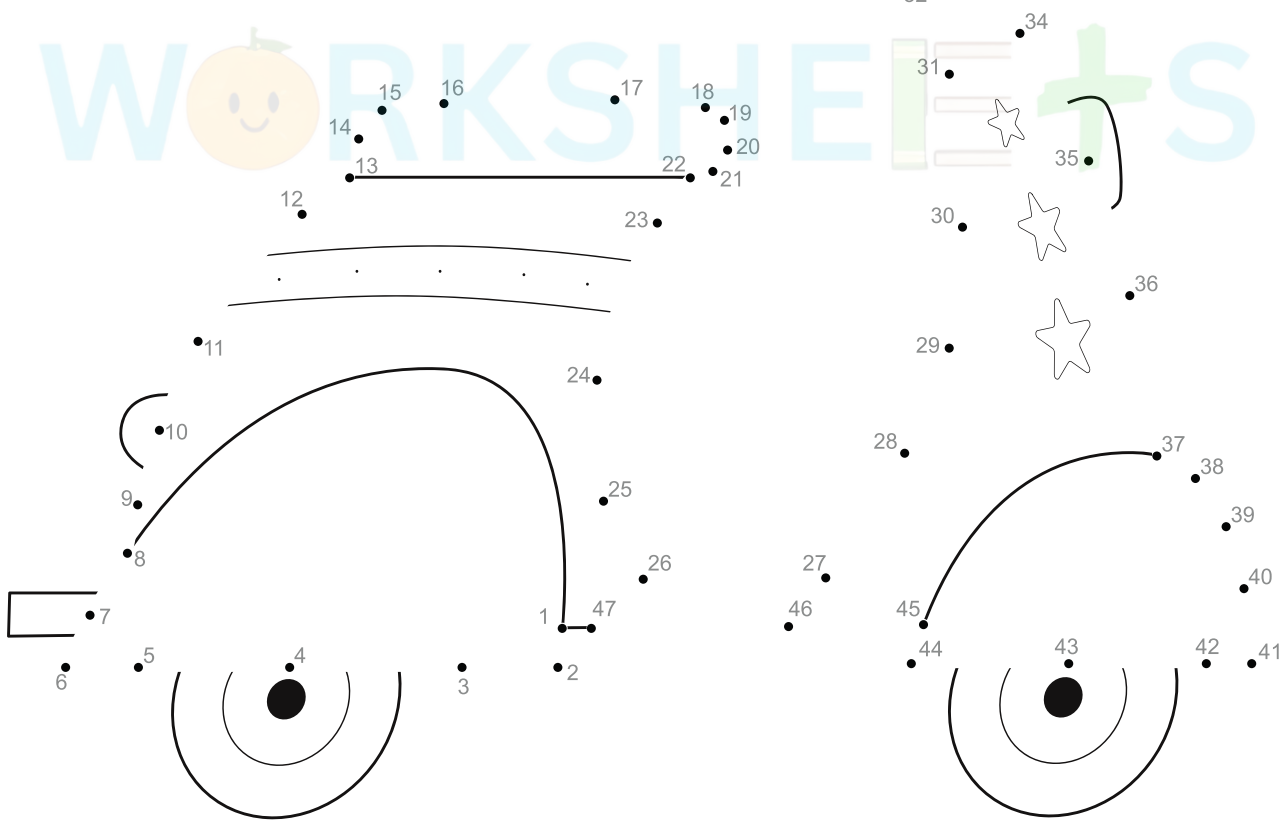
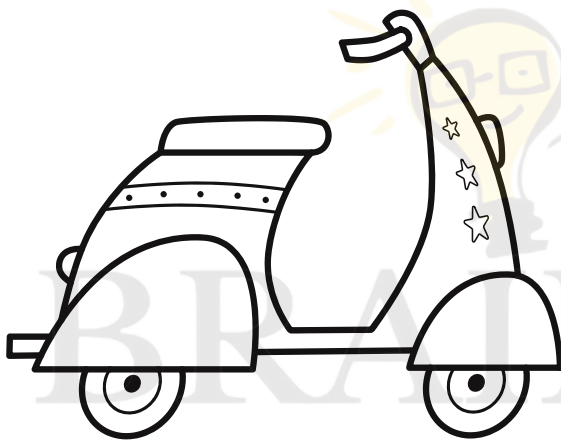



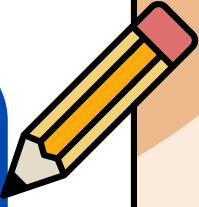

# HELICOPTER

Complete the dot-to-dot and color the vehicle:

24

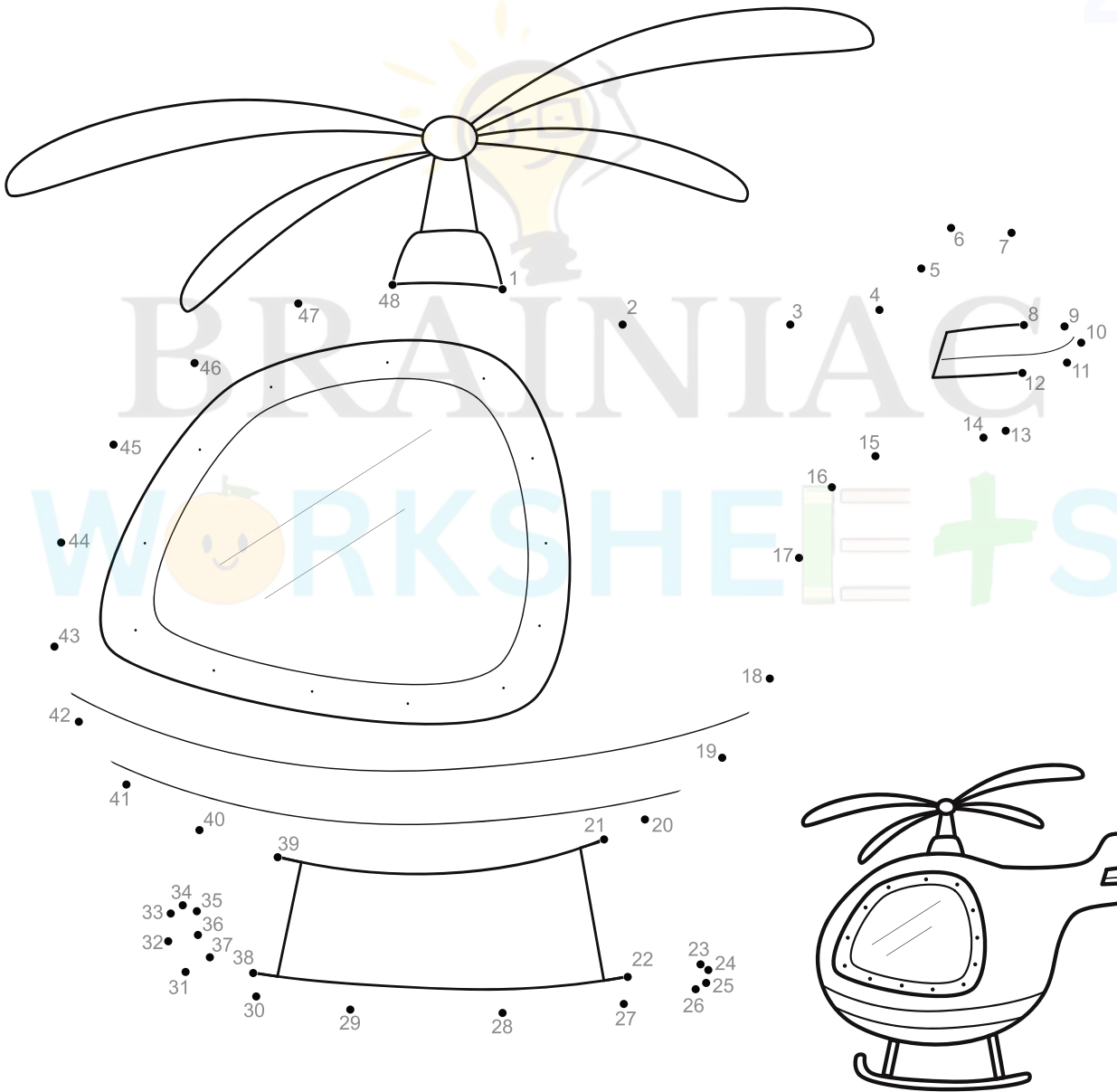

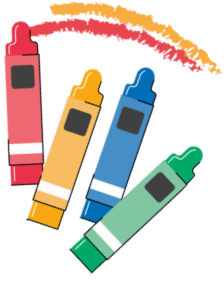

# TRAIN

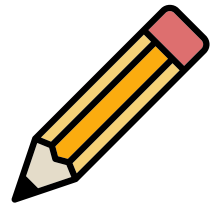

Complete the dot-to-dot and color the vehicle:

